



**Safety Technology International, Inc.**  
 2306 Airport Road • Waterford, Michigan 48327-1209  
 Phone: 248-673-9898 • Fax: 248-673-1246  
 Toll Free: 800-888-4784 • E-mail: info@sti-usa.com  
 Web: www.sti-usa.com

**Safety Technology International Ltd**  
 Taylor House • 34 Sherwood Road • Bromsgrove  
 Worcestershire • B60 3DR • England  
 Tel: +44 (0)1527 520 999 • Fax: +44 (0)1527 501 999  
 E-mail: info@sti-europe.com • Web: www.sti-europe.com

### INSTALLATION INSTRUCTIONS

1. Center wire guard over strobe.
2. Place clamps in recommended position as shown.
3. Mark clamp hole locations on wall and drill (4) 5/32 diameter holes 1 1/2 in. deep. If using anchor, drill (4) 11/32 diameter holes 1-1/2 in. deep.
4. Insert anchors and/or screws and tighten.

### WHEN USING MOUNTING PLATE

1. Attach speaker/strobe mounting plate through holes in backplate and secure the (2) #6-32 screws to the 4.0 square electrical box. Backplate must be orientated as shown to mount correctly.
2. Attach all wires to speaker/strobe mounting plate per installation instructions.
3. Attach speaker/strobe unit to speaker/strobe mounting plate per instructions.
4. Attach wire guard to backplate using the (4) clamps and screws.

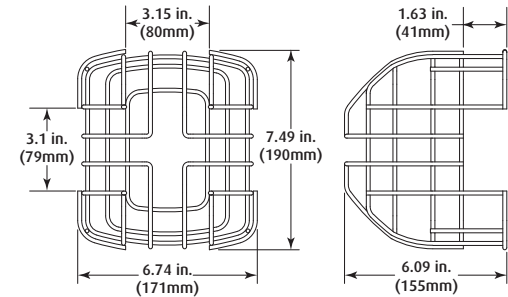
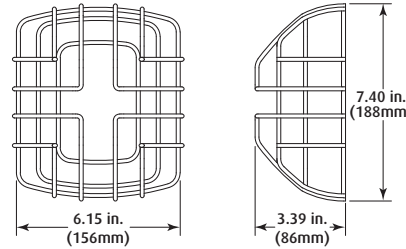
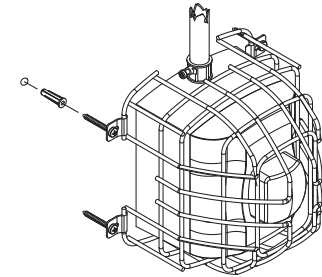
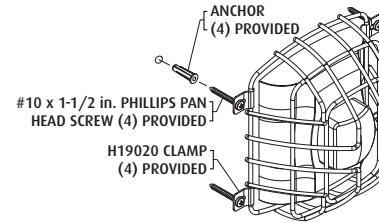

### LIGHT DE-RATING FACTOR

Light Loss %

System Sensor (SR, SW, SW-ALERT, SW-CLR-ALERT, SRK, SW K, P2R, P2W, P4R, P4W, CHSR, CHSW, P2RK, P2WK, P4RK, P4WK, SPSR, SPSR-SP, SPSR-PG, SPSW, SPSW-CLR-ALERT, SPSW-SP, SPSW-PG, SPSRV, SPSRV-SP, SPSRV-PG, SPSWV, SPSWV-SP and SPSWV-PG, SPSWK, SPSRK, SPSW-ALERT)

13.0%

System Sensor (SRH, SWH, SRHK, SWH-ALERT, SWHK, P2RH, P2WH, P4RH, P2RHK, P2WHK, P2RHK-120, SPSRH, SPSRH-SP, SPSRH-PG, SPSWH, SPSWH-SP and SPSWH-PG, SPSRHK)

0%

STI-9705

STI-9708

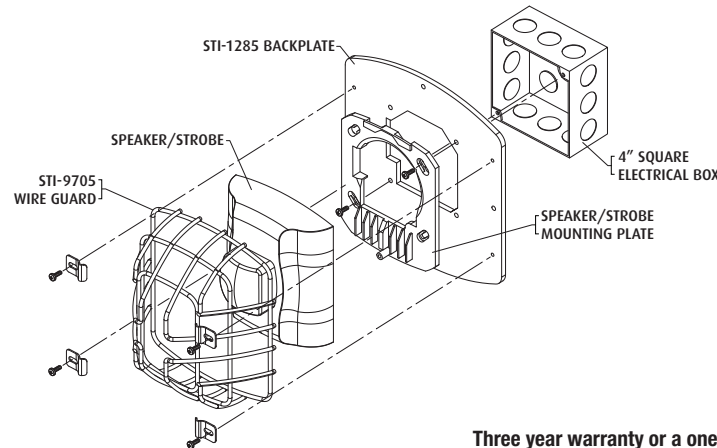

Three year warranty or a one year limited warranty (from date of purchase) on most products. See website for details. Electronic warranty form at [www.sti-usa.com/wc14](http://www.sti-usa.com/wc14).



## INSTALLATION OF STI-9705 AND STI-9708 HORN/STROBE/SPEAKER DAMAGE STOPPER®

All specifications and information shown were current as of publication and are subject to change without notice.

9705 AND 9708 JULY2010

# ADDITIONAL WIRE GUARDS AVAILABLE

Visit [www.sti-usa.com](http://www.sti-usa.com) for complete details

## SMOKE DETECTOR GUARDS

|             |              |
|-------------|--------------|
| STI-9601    | 8.25 x 2.75" |
| STI-9601-SS | 8.25 x 2.75" |
| STI-9602    | 8.25 x 4.25" |
| STI-9604    | 7 x 3.25"    |
| STI-9604-SS | 7 x 3.25"    |
| STI-9605    | 7.125 x 4.5" |
| STI-9605-SS | 7.125 x 4.5" |
| STI-9609    | 8.25 x 4.6"  |
| STI-9609-SS | 8.25 x 4.6"  |

|          |              |
|----------|--------------|
| STI-9610 | 8.25 x 6"    |
| STI-9712 | 6.87 x 4.53" |
| STI-9713 | 6.87 x 2.50" |

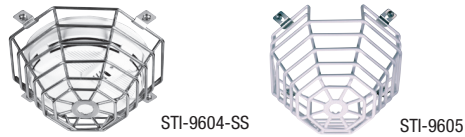

## BEAM SMOKE DETECTORS

|          |                         |
|----------|-------------------------|
| STI-9623 | 7.75 x 6 x 6"           |
| STI-9624 | 8.875 x 5.5 x 4.75"     |
| STI-9625 | 7.875 x 10.25 x 12.625" |
| STI-9706 | 10.82 x 9.32 x 4"       |
| STI-9707 | 11 x 9.62 x 5.5"        |
| STI-9840 | 6.61 x 5.78"            |
| STI-9841 | 11.52 x 10 x 3.58"      |
| STI-9845 | 6.7 x 9.2 x 4.07"       |



## PIR GUARDS

|          |                     |
|----------|---------------------|
| STI-9618 | 4.62 x 5.37 x 3"    |
| STI-9619 | 7.75 x 5.37 x 5.62" |
| STI-9620 | 6.25 x 4 x 2.25"    |
| STI-9621 | 7 x 5.75 x 4.50"    |
| STI-9622 | 8.75 x 4 x 3.75"    |



## CLOCK/BELL WIRE CAGES

|             |                |
|-------------|----------------|
| STI-9631    | 10.5" Diameter |
| STI-9631-SS | 10.5" Diameter |
| STI-9631-R  | 10.5" Diameter |
| STI-9632    | 16.5" Diameter |
| STI-9632-SS | 16.5" Diameter |
| STI-9633    | 20" Diameter   |

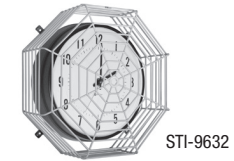

## EXIT SIGN WIRE CAGES

|          |                       |
|----------|-----------------------|
| STI-9640 | 10.5 x 13.75 x 2.75"  |
| STI-9740 | 15.5 x 20.5 x 6"      |
| STI-9741 | 14.80 x 16.09 x 5.35" |
| STI-9742 | 15.59 x 16.09 x 3.30" |



## BAY & OUTDOOR LIGHT WIRE CAGES

|          |                |
|----------|----------------|
| STI-9702 | 21.43 x 22.50" |
| STI-9709 | 24.5 x 26"     |
| STI-9796 | 14 x 16"       |



## EMERGENCY LIGHT CAGES

|          |                        |
|----------|------------------------|
| STI-9641 | 19.7 x 14.6 x 4"       |
| STI-9644 | 8.7 x 17.7 x 5"        |
| STI-9645 | 13.8 x 21.7 x 5.9"     |
| STI-9649 | 10.75 x 24.75 x 11.25" |
| STI-9703 | 5 x 13.5 x 4"          |



## BEACON & SOUNDER CAGES

|          |              |
|----------|--------------|
| STI-9614 | 7.9 x 6"     |
| STI-9615 | 3.7 x 3.5"   |
| STI-9617 | 5.9 x 4.9"   |
| STI-9664 | 3.86 x 6.18" |
| STI-9665 | 7 x 8.43"    |



## MISCELLANEOUS WIRE CAGES

|          |                      |
|----------|----------------------|
| STI-9651 | 29.5 x 53.5 x 4"     |
| STI-9705 | 7.4 x 6.15 x 3.39"   |
| STI-9708 | 7.49 x 6.74 x 6.09"  |
| STI-9711 | 8.26 x 8.26 x 3.54"  |
| STI-9714 | 8.55 x 8.55 x 6.23"  |
| STI-9716 | 17 x 17 x 25"        |
| STI-9717 | 6.1 x 9.3 x 2.4"     |
| STI-9720 | 6.1 x 9.3 x 4.9"     |
| STI-9729 | 7 x 7 x 7"           |
| STI-9730 | 12 x 12 x 12"        |
| STI-9796 | 21.43 x 22.5"        |
| STI-9880 | 10.45 x 62.75 x 6.2" |
| STI-9881 | 10.45 x 98.25 x 6.2" |

